

JWB010US

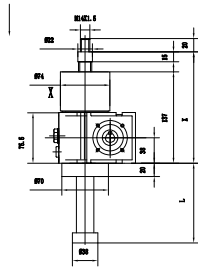

JWB010DS

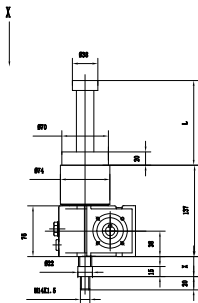

JWB010UM

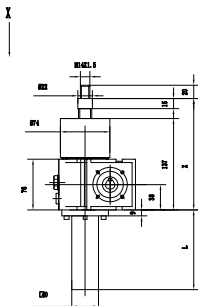

JWB010DM

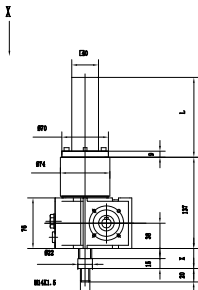

JWB010UR

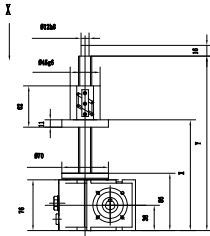

JWB010DR

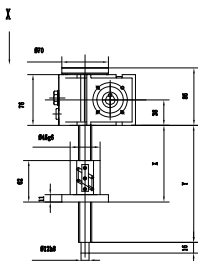

顶端连接方式

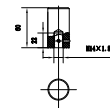
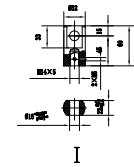
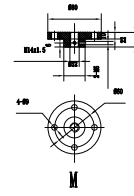

防尘罩

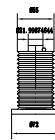

J

X向

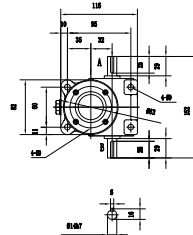

行程 (mm) Journey	U S				L
	X		X(1)		
	MIN	MAX	MIN	MAX	
100	162	262	212	312	194
200	162	362	212	412	294
300	162	462	252	552	434
400	162	562	252	652	534
500	162	662	287	787	669
600	162	762	287	887	769

行程 (mm) Journey	D S				L
	X		X(1)		
	MIN	MAX	MIN	MAX	
100	25	125	75	175	194
200	25	225	75	275	294
300	25	325	115	415	434
400	25	425	115	515	534
500	25	525	150	650	669
600	25	625	150	750	769

行程 (mm) Journey	U M				L
	X		X(1)		
	MIN	MAX	MIN	MAX	
100	162	262	212	312	194
200	162	362	212	412	294
300	162	462	252	552	434
400	162	562	252	652	534
500	162	662	287	787	669
600	162	762	287	887	769

行程 (mm) Journey	D M				L
	X		X(1)		
	MIN	MAX	MIN	MAX	
100	25	125	75	175	194
200	25	225	75	275	294
300	25	325	115	415	434
400	25	425	115	515	534
500	25	525	150	650	669
600	25	625	150	750	769

行程 (mm) Journey	U R			Y
	X			
	MIN	MAX		
100	108	208		265
200	108	308		365
300	108	408		465
400	108	508		565
500	108	608		665
600	108	708		765

行程 (mm) Journey	D R			Y
	X			
	MIN	MAX		
100	69	169		179
200	69	269		279
300	69	369		379
400	69	469		479
500	69	569		579
600	69	669		679

公司名称	北京赛尼传动有限公司	设计		日期	04. 11. 13
减速机型号	JWB010升降机	审核		日期	04. 11. 15

JWB025US

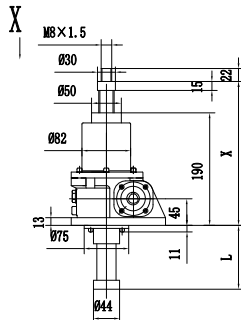

JWB025DS

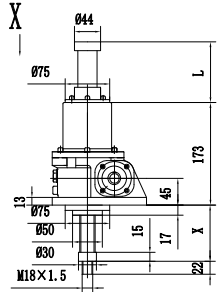

JWB025UM

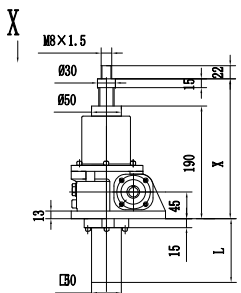

JWB025DM

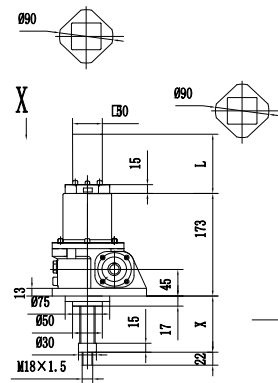

JWB025UR

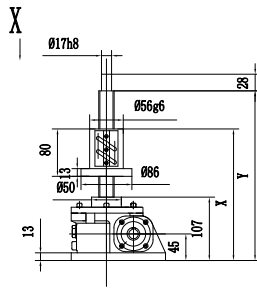

JWB025DR

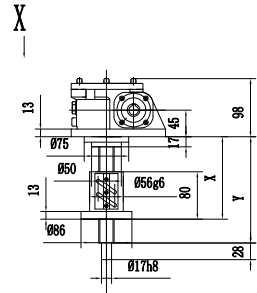

顶端连接方式

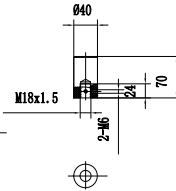
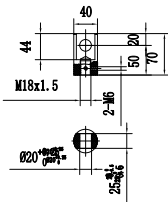
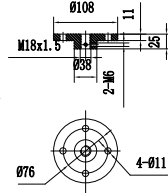

防尘罩

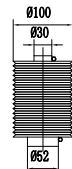

J

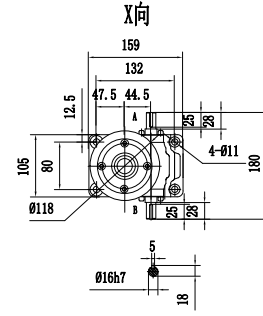

行程 mm	U S				
	X		X(1)		L
	MIN	MAX	MIN	MAX	
100	215	315	230	330	149
200	215	415	230	430	249
300	215	515	250	550	369
400	215	615	250	650	469
500	215	715	270	770	589
600	215	815	270	870	689
800	215	1015	290	1090	909

行程 mm	D S				
	X		X(1)		L
	MIN	MAX	MIN	MAX	
100	42	142	57	157	149
200	42	242	57	257	249
300	42	342	77	377	369
400	42	442	77	477	469
500	42	542	97	597	589
600	42	642	97	697	689
800	42	842	117	917	909

行程 mm	U M				
	X		X(1)		L
	MIN	MAX	MIN	MAX	
100	215	315	230	330	149
200	215	415	230	430	249
300	215	515	250	550	369
400	215	615	250	650	469
500	215	715	270	770	589
600	215	815	270	870	689
800	215	1015	290	1090	909

行程 mm	D M				
	X		X(1)		L
	MIN	MAX	MIN	MAX	
100	42	142	57	157	149
200	42	242	57	257	249
300	42	342	77	377	369
400	42	442	77	477	469
500	42	542	97	597	589
600	42	642	97	697	689
800	42	842	117	917	909

行程 mm	D R		
	X		L
	MIN	MAX	
100	133	233	309
200	133	333	409
300	133	433	509
400	133	533	609
500	133	633	709
600	133	733	809
800	133	933	1009

行程 mm	U R		
	X		L
	MIN	MAX	
100	108	208	219
200	108	308	319
300	108	408	419
400	108	508	519
500	108	608	619
600	108	708	719
800	108	808	819

公司名称	北京赛尼传动有限公司	设计	日期	04. 11. 10
减速机型号	JWM025升降机	审核	日期	04. 11. 13

JWB050US

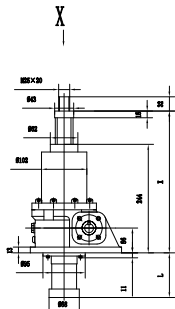

JWB050DS

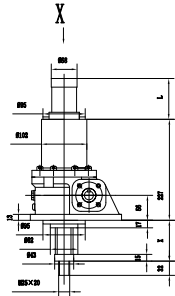

JWB050UM

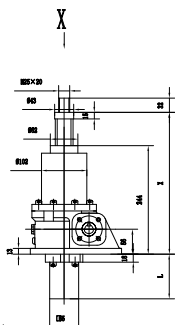

JWB050DM

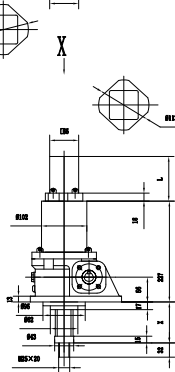

JWB050UR

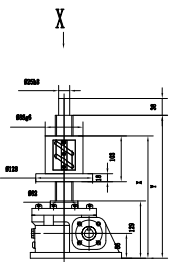

JWB050DR

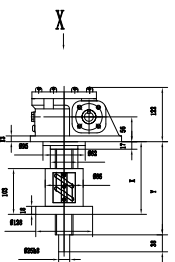

顶端连接方式

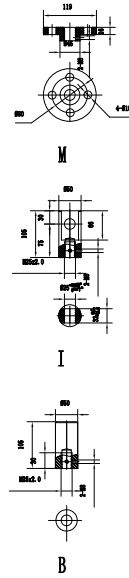

防尘罩

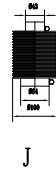

X向

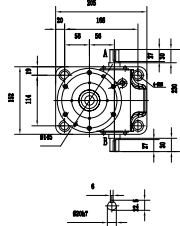

行程 (mm)	D S				
	X		X(O)		L
行程 (mm)	MIN	MAX	MIN	MAX	L
100	259	359	284	384	147
200	259	459	284	484	247
300	259	559	304	604	357
400	259	659	304	704	457
500	259	759	304	804	557
600	259	859	304	904	657
800	259	1059	344	1144	907
1000	259	1259	354	1354	1127

行程 (mm)	D S				
	X		X(O)		L
行程 (mm)	MIN	MAX	MIN	MAX	L
100	42	142	57	157	147
200	42	242	57	257	247
300	42	342	77	377	357
400	42	442	77	477	457
500	42	542	97	597	557
600	42	642	97	697	657
800	42	842	117	917	907
1000	42	1042	137	1137	1127

行程 (mm)	D M				
	X		X(O)		L
行程 (mm)	MIN	MAX	MIN	MAX	L
100	259	359	284	384	175
200	259	459	284	484	275
300	259	559	304	604	375
400	259	659	304	704	475
500	259	759	304	804	575
600	259	859	304	904	675
800	259	1059	344	1144	925
1000	259	1259	354	1354	1155

行程 (mm)	D R				
	X		X(O)		L
行程 (mm)	MIN	MAX	MIN	MAX	L
100	157	257	157	257	175
200	157	357	157	357	275
300	157	457	157	457	375
400	157	557	157	557	475
500	157	657	157	657	575
600	157	757	157	757	675
800	157	957	157	957	925
1000	157	1157	157	1157	1155

行程 (mm)	D R			
	X		Y	
行程 (mm)	MIN	MAX	MIN	MAX
100	130	230	342	442
200	130	330	442	542
300	130	430	542	642
400	130	530	642	742
500	130	630	742	842
600	130	730	842	942
800	130	930	942	1142
1000	130	1130	1142	1342

公司名称	北京赛尼传动有限公司	设计	日期	04.11.10
减速机型号	JWM025升降机	审核	日期	04.11.13

JWB100US

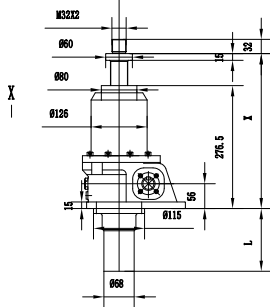

JWB100DS

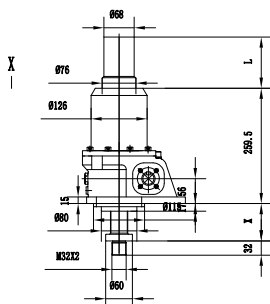

JWB100M

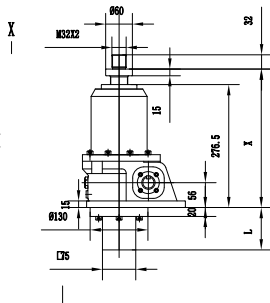

JWB100DM

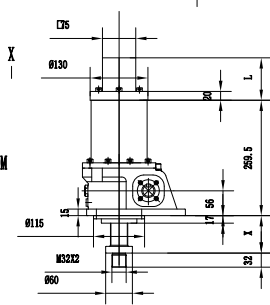

JWB100UR

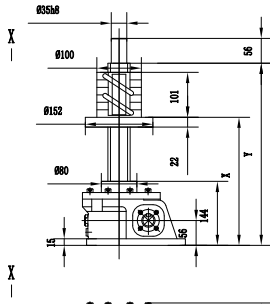

JWB100DR

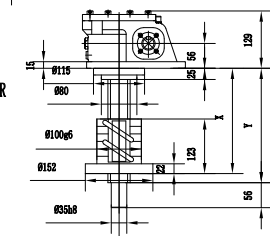

顶端连接方式

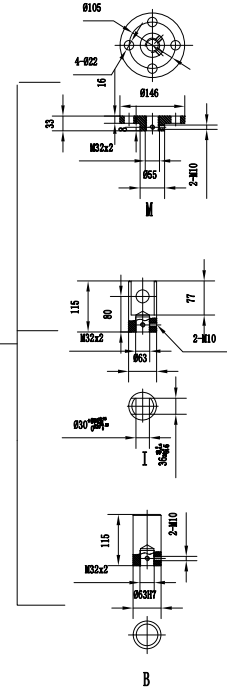

防尘罩

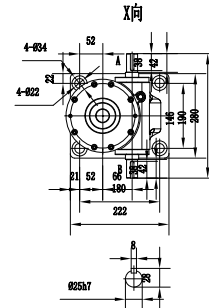
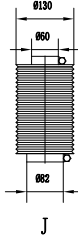

行程 (mm) Jmax	U S				
	X		X(O)		L
	MIN	MAX	MIN	MAX	
100	302	402	312	412	151
200	302	502	312	512	252
300	302	602	327	627	356
400	302	702	327	727	456
500	302	802	353	853	591
600	302	902	353	953	691
800	302	1102	367	1157	906
1000	302	1302	377	1377	1116
1200	302	1502	402	1602	1341

行程 (mm) Jmax	D S				
	X		X(O)		L
	MIN	MAX	MIN	MAX	
100	42	142	52	152	151
200	42	242	52	252	252
300	42	342	67	357	356
400	42	442	67	457	456
500	42	542	92	592	591
600	42	642	92	692	691
800	42	842	107	907	906
1000	42	1042	117	1117	1116
1200	42	1242	142	1342	1341

行程 (mm) Jmax	U M				
	X		X(O)		L
	MIN	MAX	MIN	MAX	
100	302	402	312	412	192
200	302	502	312	512	292
300	302	602	327	627	497
400	302	702	327	727	507
500	302	802	353	853	632
600	302	902	353	953	732
800	302	1102	367	1157	947
1000	302	1302	377	1377	1157
1200	302	1502	402	1602	1382

行程 (mm) Jmax	D M				
	X		X(O)		L
	MIN	MAX	MIN	MAX	
100	42	142	52	152	192
200	42	242	52	252	292
300	42	342	67	357	497
400	42	442	67	457	507
500	42	542	92	592	632
600	42	642	92	692	732
800	42	842	107	907	947
1000	42	1042	117	1117	1157
1200	42	1242	142	1342	1382

行程 (mm) Jmax	U R			
	X		Y	
	MIN	MAX	MIN	MAX
100	176	276	307	407
200	176	376	407	507
300	176	476	507	607
400	176	576	607	707
500	176	676	707	807
600	176	776	807	907
800	176	976	1007	1107
1000	176	1176	1207	1307
1200	176	1376	1407	1507

行程 (mm) Jmax	D R			
	X		Y	
	MIN	MAX	MIN	MAX
100	158	258	268	368
200	158	358	368	468
300	158	458	468	568
400	158	558	568	668
500	158	658	668	768
600	158	758	768	868
800	158	958	968	1068
1000	158	1158	1168	1268
1200	158	1358	1368	1468

公司名称	北京赛尼传动有限公司	设计	日期	04.11.10
减速机型号	JWB100升降机	审核	日期	04.11.13

JWB150US

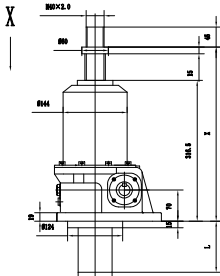

JWB150DS

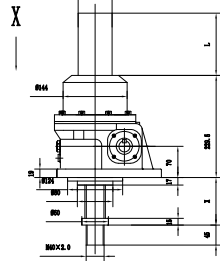

JWB150UM

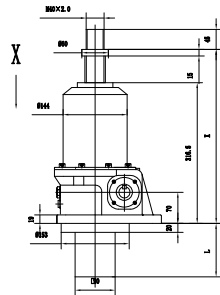

JWB150DM

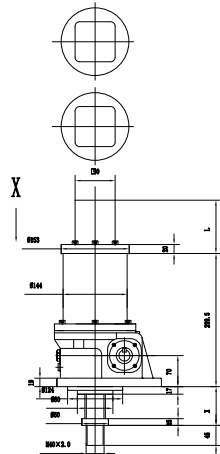

JWB150UR

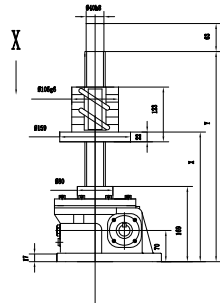

JWB150DR

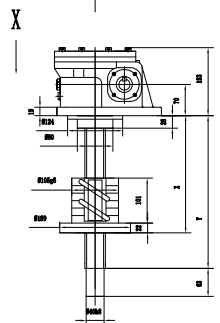

顶端连接方式

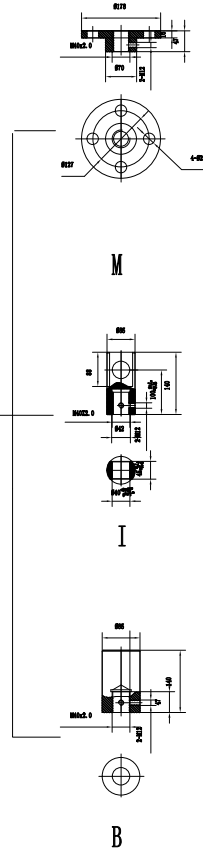

防尘罩



X向

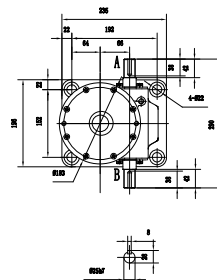

行程 (mm)	U S				
	X		X(O)		L
行程 (mm)	MIN	MAX	MIN	MAX	L
100	342	442	352	452	151
200	342	542	352	552	252
300	342	642	367	667	356
400	342	742	367	767	456
500	342	842	382	862	561
600	342	942	382	952	661
800	342	1142	407	1207	906
1000	342	1342	417	1417	1116
1200	342	1542	442	1642	1341

行程 (mm)	D S				
	X		X(O)		L
行程 (mm)	MIN	MAX	MIN	MAX	L
100	42	142	52	152	151
200	42	242	52	252	252
300	42	342	67	367	356
400	42	442	67	467	456
500	42	542	92	562	561
600	42	642	92	662	661
800	42	842	107	907	906
1000	42	1042	117	1117	1116
1200	42	1242	142	1342	1341

行程 (mm)	U M				
	X		X(O)		L
行程 (mm)	MIN	MAX	MIN	MAX	L
100	342	442	352	452	221
200	342	542	352	552	321
300	342	642	367	667	426
400	342	742	367	767	536
500	342	842	382	862	661
600	342	942	382	952	761
800	342	1142	407	1207	976
1000	342	1342	417	1417	1186
1200	342	1542	442	1642	1411

行程 (mm)	D M				
	X		X(O)		L
行程 (mm)	MIN	MAX	MIN	MAX	L
100	42	142	52	152	221
200	42	242	52	252	321
300	42	342	67	367	426
400	42	442	67	467	536
500	42	542	92	562	661
600	42	642	92	662	761
800	42	842	107	907	976
1000	42	1042	117	1117	1186
1200	42	1242	142	1342	1411

行程 (mm)	U R			
	X		Y	
行程 (mm)	MIN	MAX	MIN	MAX
100	201	301	301	412
200	201	401	401	512
300	201	501	501	612
400	201	601	601	712
500	201	701	701	812
600	201	801	801	912
800	201	1001	1001	1112
1000	201	1201	1201	1312
1200	201	1401	1401	1512

行程 (mm)	D R			
	X		Y	
行程 (mm)	MIN	MAX	MIN	MAX
100	161	261	261	272
200	161	361	361	372
300	161	461	461	472
400	161	561	561	572
500	161	661	661	672
600	161	761	761	772
800	161	961	961	972
1000	161	1161	1161	1172
1200	161	1361	1361	1372

公司名称	北京赛尼传动有限公司	设计	日期	04.11.10
减速机型号	JWB150升降机	审核	日期	04.11.13

JWB200US

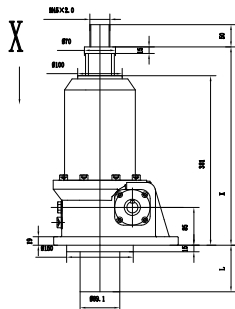

JWB200DS

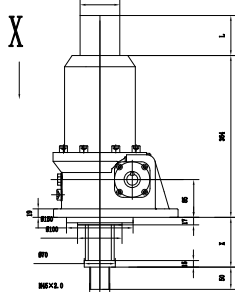

JWB200UM

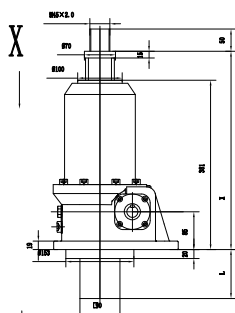

JWB200DM

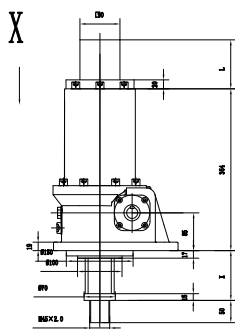

JWB200UR

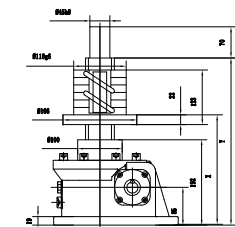

JWB200DR

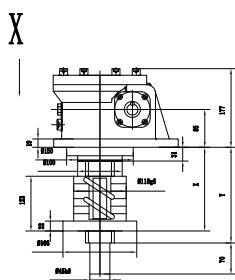

顶端连接方式

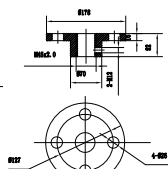

M

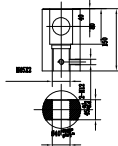

I

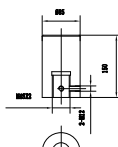

B

防尘罩

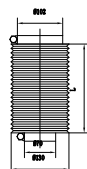

J

X向

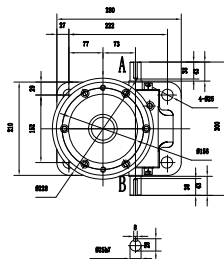

行程 (mm)	U S			
	X		X(O)	
	MIN	MAX	MIN	MAX
100	406	505	416	515
200	406	605	416	615
300	406	705	431	731
400	406	805	431	831
500	406	905	456	956
600	406	1005	456	1056
800	406	1205	471	1271
1000	406	1405	481	1481
1200	406	1605	506	1706

行程 (mm)	D S			
	X		X(O)	
	MIN	MAX	MIN	MAX
100	42	142	52	152
200	42	242	52	252
300	42	342	67	367
400	42	442	67	467
500	42	542	92	592
600	42	642	92	692
800	42	842	107	907
1000	42	1042	117	1117
1200	42	1242	142	1342

行程 (mm)	U M			
	X		X(O)	
	MIN	MAX	MIN	MAX
100	406	505	416	515
200	406	605	416	615
300	406	705	431	731
400	406	805	431	831
500	406	905	456	956
600	406	1005	456	1056
800	406	1205	471	1271
1000	406	1405	481	1481
1200	406	1605	506	1706

行程 (mm)	D M			
	X		X(O)	
	MIN	MAX	MIN	MAX
100	42	142	52	152
200	42	242	52	252
300	42	342	67	367
400	42	442	67	467
500	42	542	92	592
600	42	642	92	692
800	42	842	107	907
1000	42	1042	117	1117
1200	42	1242	142	1342

行程 (mm)	U R		
	X		Y
	MIN	MAX	
100	224	324	435
200	224	424	535
300	224	524	635
400	224	624	735
500	224	724	835
600	224	824	935
800	224	1024	1135
1000	224	1224	1335
1200	224	1424	1535

行程 (mm)	D R		
	X		Y
	MIN	MAX	
100	154	254	274
200	154	354	374
300	154	454	474
400	154	554	574
500	154	654	674
600	154	754	774
800	154	954	974
1000	154	1154	1174
1200	154	1354	1374

公司名称	北京赛尼传动有限公司	设计	日期	04. 11. 10
减速机型号	JWB200升降机	审核	日期	04. 11. 13

JWB300US

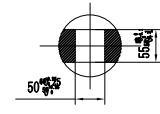
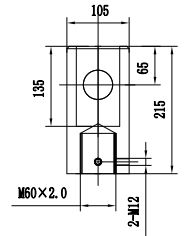
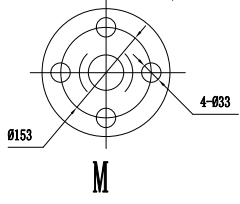
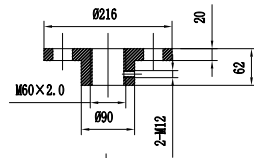
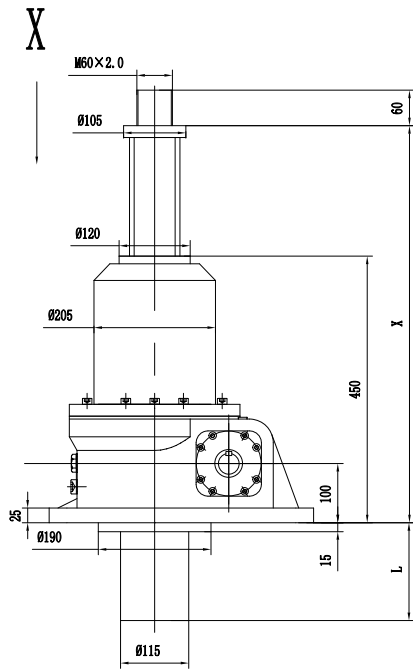

I

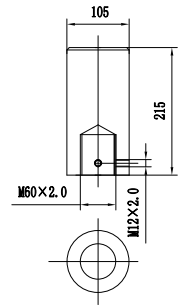

B

顶端连接方式

JWB300DS

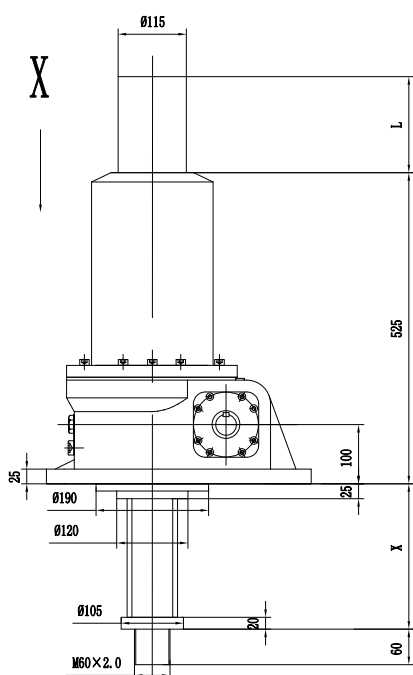

防尘罩

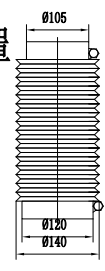

J

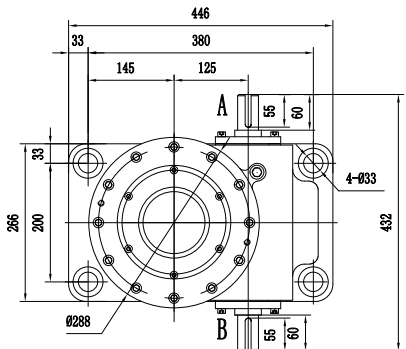

X向

行程 (mm) Journey	U S				L
	X		Y(1)		
	MIN	MAX	MIN	MAX	
100	480	580	490	590	160
200	480	680	490	690	260
300	480	780	505	805	375
400	480	880	505	905	475
500	480	980	520	1020	590
600	480	1080	520	1120	690
800	480	1280	535	1335	905
1000	480	1480	555	1555	1125
1200	480	1680	565	1765	1335
1500	480	1980	590	2090	1660
行程 (mm) Journey	D S				L
	X		Y(1)		
	MIN	MAX	MIN	MAX	
100	55	155	65	165	160
200	55	255	65	265	260
300	55	355	80	380	375
400	55	455	80	480	475
500	55	555	95	595	590
600	55	655	95	695	690
800	55	855	110	905	905
1000	55	1055	130	1125	1125
1200	55	1255	140	1335	1335
1500	55	1555	165	1665	1660

公司名称	北京赛尼传动有限公司 设计	日期	04. 11. 10
减速机型号	JWB300升降机 审核	日期	04. 11. 13

JWB500US

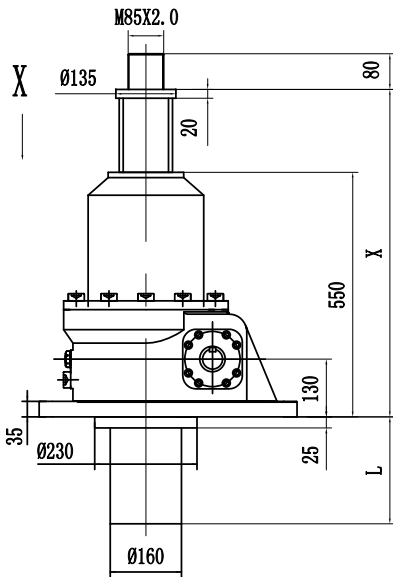

JWB50DS

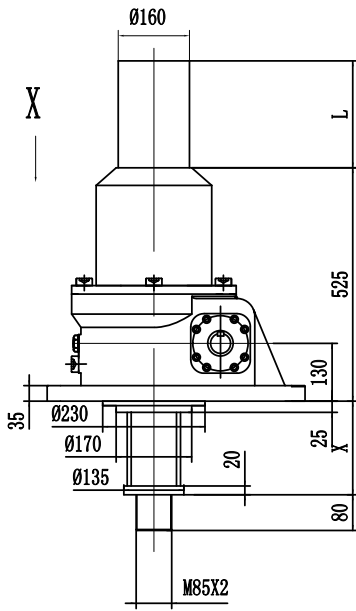

顶端连接方式

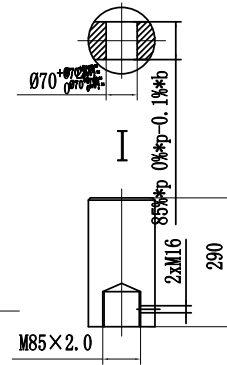
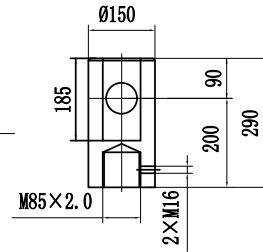
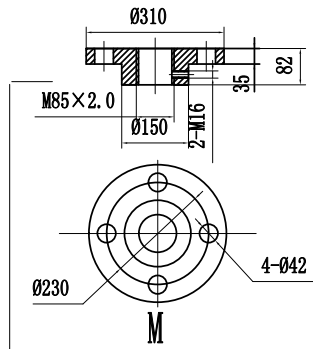

防尘罩

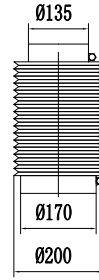

X向

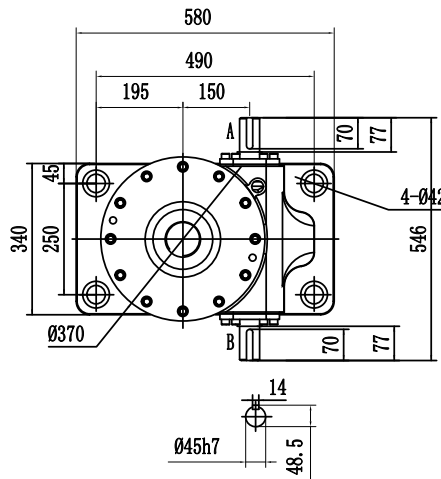

行程 (mm)	U S				
	x		x(O)		L
	MIN	MAX	MIN	MAX	
100	580	680	585	685	165
200	580	780	585	785	265
300	580	880	605	905	365
400	580	980	605	1005	465
500	580	1080	615	1115	565
600	580	1180	615	1215	665
800	580	1380	630	1430	910
1000	580	1580	645	1645	1125
1200	580	1780	655	1855	1335
1500	580	2080	675	2175	1665
行程 (mm)	D S				
	x		x(O)		L
	MIN	MAX	MIN	MAX	
100	55	155	60	160	165
200	55	255	60	260	265
300	55	355	80	360	365
400	55	455	80	460	465
500	55	555	90	560	565
600	55	655	90	660	665
800	55	855	105	905	910
1000	55	1055	120	1120	1125
1200	55	1255	130	1330	1335
1500	55	1555	150	1650	1665